



INSTALLATION MANUAL

Wall-mounted Fan Coil Type



Thank you very much for purchasing our air conditioner.
Before using your air conditioner, please read this manual carefully and keep it for future reference.

| | |
|---------------------------------------|---|
| PRECAUTIONS..... | 1 |
| INSTALLATION INFORMATION..... | 2 |
| ATTACHED FITTINGS..... | 3 |
| INSPECTING AND HANDLING THE UNIT..... | 4 |
| INDOOR UNIT INSTALLATION..... | 4 |
| WATER PIPE INSTALLATION..... | 6 |
| WIRING CHART..... | 6 |

1. PRECAUTIONS

- Be sure to be in conformity with the local, national and international laws and regulations.
- Read "PRECAUTIONS" carefully before installation.
- The following precautions include important safety items. Observe them and never forget.
- Keep this manual in a handy place for future reference.
- Before out from factory, FAN COIL UNIT (AIR UNITS) has passed Fan Coil Overpressure Resistant Test, Statically and Dynamically Balanced Adjustment, Noise Test, Air (cool) Volume Test, Electric Property Test, Outline Quality Detection.

The safety precautions listed here are divided into two categories. In either case, important safety information is listed which must be read carefully.



WARNING

Failure to observe a warning may result in death.



CAUTION

Failure to observe a caution may result in injury or damage to the equipment.

After completing the installation, make sure that the unit operates properly during the start-up operation. Please instruct the customer on how to operate the unit and keep it maintained.



WARNING

Be sure only trained and qualified service personnel to install, repair or service the equipment.

Improper installation, repair, and maintenance may result in electric shocks, short-circuit, leaks, fire or other damage to the equipment.

Install according to this installation instructions strictly. If installation is defective, it will cause water leakage, electrical shock and fire.

When installing the unit in a small room, take measures against to keep refrigerant concentration from exceeding allowable safety limits in the event of refrigerant leakage. Contact the place of purchase for more information. Excessive refrigerant in a closed ambient can lead to oxygen deficiency.

Use the attached accessories parts and specified parts for installation.

otherwise, it will cause the set to fall, water leakage, electrical shock and fire.

The appliance must be installed 2.3m above floor.

The appliance shall not be installed in the laundry.

Before obtaining access to terminals, all supply circuits must be disconnected.

The appliance must be positioned so that the plug is accessible.

The enclosure of the appliance shall be marked by word, or by symbols, with the direction of the fluid flow.

For electrical work, follow the local national wiring standard, regulation and this installation instructions. An independent circuit and single outlet must be used.

If electrical circuit capacity is not enough or defect in electrical work, it will cause electrical shock fire.

Use the specified cable and connect tightly and clamp the cable so that no external force will be acted on the terminal.

If connection or fixing is not perfect, it will cause heat-up or fire at the connection.

Wiring routing must be properly arranged so that control board cover is fixed properly.

If control board cover is not fixed perfectly, it will cause heat-up at connection point of terminal, fire or electrical shock.

If the supply cord is damaged, it must be replaced by the manufacture or its service agent or a similarly qualified person in order to avoid a hazard.

An all-pole disconnection switch having a contact separation of at least 3mm in all poles should be connected in fixed wiring.

When carrying out piping connection, take care not to let air substances go into refrigeration cycle.

Otherwise, it will cause lower capacity, abnormal high pressure in the refrigeration cycle.

Do not modify the length of the power supply cord or use of extension cord, and do not share the single outlet with other electrical appliances.

Otherwise, it will cause fire or electrical shock.

If the water leaks during installation, ventilate the area immediately.

After completing the installation work, check that the water does not leak.

The cool water in the unit is not lower than 3°C, hot water is not higher than 70°C. Water in the unit must clean, air quality must meet to the standard of PH=6.5~7.5.



CAUTION

Ground the air conditioner.

Do not connect the ground wire to gas or water pipes, lightning rod or a telephone ground wire. Incomplete grounding may result in electric shocks.

Be sure to install an earth leakage breaker.

Failure to install an earth leakage breaker may result in electric shocks.

Connect the outdoor unit wires, then connect the indoor unit wires.

You are not allowed to connect the air conditioner with the power source until wiring and piping the air conditioner is done.

While following the instructions in this installation manual, install drain piping in order to ensure proper drainage and insulate piping in order to prevent condensation.

Improper drain piping may result in water leakage and property damage.

Install the indoor and outdoor units, power supply wiring and connecting wires at least 1 meter away from televisions or radios in order to prevent image interference or noise.

Depending on the radio waves, a distance of 1 meter may not be sufficient enough to eliminate the noise.

This appliance is not intended for use by persons (including children) with reduced physical, sensory or mental capabilities, or lack of experience and knowledge, unless they have been given supervision or instruction concerning use of the appliance by a person responsible for their safety.

Condensate water may be generated when machine operates in an open environment.

Don't install the air conditioner in the following locations:

- There is petrolatum existing.
- There is salty air surrounding (near the coast).
- There is caustic gas (the sulfide, for example) existing in the air (near a hot spring).
- The Volt vibrates violently (in the factories).
- In buses or cabinets.
- In kitchen where it is full of oil gas.
- There is strong electromagnetic wave existing.
- There are inflammable materials or gas.
- There is acid or alkaline liquid evaporating.
- Other special conditions.

2. INSTALLATION INFORMATION









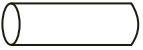

- To install properly, please read this "installation manual" at first.
- The air conditioner must be installed by qualified persons.
- When installing the indoor unit or its tubing, please follow this manual as strictly as possible.
- If the air conditioner is installed on a metal part of the building, it must be electrically insulated according to the relevant standards to electrical appliances.
- When all the installation work is finished, please turn on the power only after a thorough check.
- Regret for no further announcement if there is any change of this manual caused by product improvement.

INSTALLATION ORDER

- Select the location;
- Install the indoor unit;
- Install the outdoor unit;
- Connect the drain pipe;
- Wiring;
- Test operation.

3. ATTACHED FITTINGS

Please check whether the following fittings are of full scope. If there are some spare fittings , please restore them carefully.

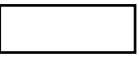
| NAME | SHAPE | QUANTITY | FUNCTION |
|---|---|----------|---|
| 1. Screw ST3.9x25 for installation board |  | 8 | Secure the installation board |
| 2. Plastic expanded tube |  | 8 | _____ |
| 3. Wrapping tape |  | 1 | _____ |
| 4. Drain pipe |  | 1 | _____ |
| 5. Wall conduit cover |  | 1 | _____ |
| 6. Remote controller (including operation manual) |  | 1 | _____ |
| 7. Frame |  | 1 | Hold the remote controller |
| 8. Mounting screw(ST2.9 × 10-C-H) |  | 2 | Insulation Holder for remote controller |
| 9. Alkaline dry batteries (AM4) |  | 2 | _____ |
| 10. Owner's manual | _____ | 1 | _____ |
| 11. Installation manual | _____ | 1 | This manual |
| 12. seel gasket |  | 4 | For connect water pipe |
| 13 Network matching wire |  | 1 | The indoor unit which at the terminal of communication system should connect a impedance between port X and port Y. |
| 14. insulation |  | 1 | Prevent the walls from getting damp |

Cautions on remote controller installation:

- Never throw or beat the controller.
- Before installation, operate the remote controller to determine its location in a reception range.
- Keep the remote controller at least 1m apart from the nearest TV set or stereo equipment. (it is necessary to prevent image disturbances or noise interferences.)
- Do not install the remote controller in a place exposed to direct sunlight or close to a heating source, such as a stove.
- Note that the positive and negative poles are right positions when loading batteries.
- This manual is subject to changes due to technological improvement without further notices.

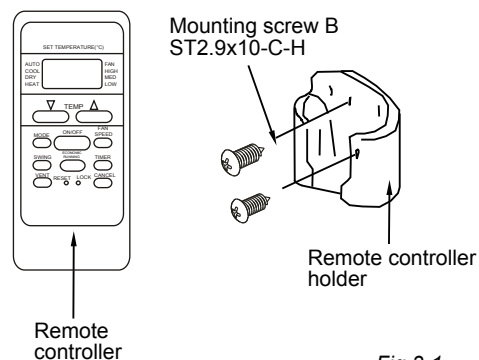



Fig.3-1

4. INSPECTING AND HANDLING THE UNIT

At delivery, the package should be checked and any damage should be reported immediately to the carrier claims agent.

When handling the unit, take into account the following:

- 1  Fragile, handle the unit with care.
- 2 Choose on before hand the path along which the unit is to be brought in.
- 3 Move this unit as originally package as possible.
- 4 When lifting the unit , always use protectors to prevent belt damage and pay attention to the position of the unit's centre of gravity.

5. INDOOR UNIT INSTALLATION

5.1 Installation place

Before installing the unit, be sure to confirm with the user whether there are wires, water pipes, air pipes and so on in the wall or ground of the installation site to avoid accidents due to damage.

Installation in the following places may cause trouble. If it is unavoidable, please consult with the local dealer.

- A place full of machine oil.
- A saline place such as coast.
- A place full of sulfide gas such as hot-spring resort.
- Places where there are high frequency machines such as wireless equipment, welding
- Machine, and medical facility.
- A place there is no combustive gases and volatile matter.
- A place of special environmental conditions.

■ Indoor Unit

- A place where is no obstacle near the inlet and outlet area.
- A place which can bear the indoor unit.
- A place which is convenient to maintenance.
- A place which provides the space around the indoor unit as required right in the diagram.
- There is strong electromagnetic wave exist-ing.
- A place which is far from heat, steam and inflammable gas.

5.2 Drilling A Hole and Mounting Installation Board

Installation Board and Its Direction (unit: mm)

250\300\400 type

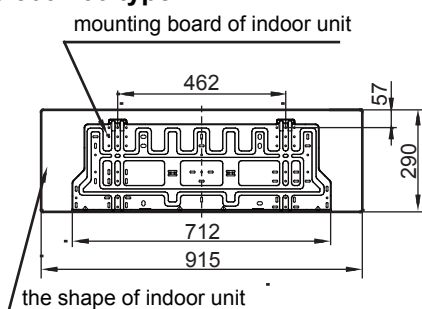

Fig.5-1

500\600 type

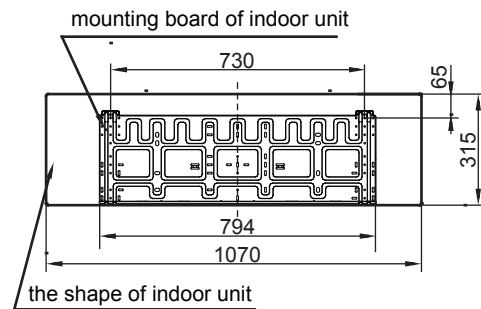

Fig.5-2

1 Fix the installation board.

- It is recommended to install insulation between mounting board and wall to avoid wall getting damp.
- Install the installation board horizontally on structural parts in the wall with the spaces provided around the plate.
- In case of brick, concrete or similar type walls, make 5mm dia. holes in the wall. Insert clip anchors for appropriate mounting screws.

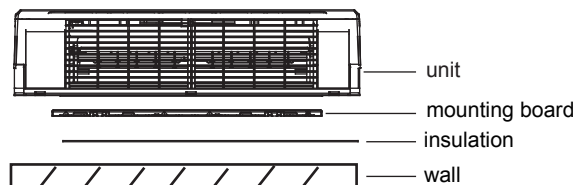

Fig.5-3

- Fix the installation board on the wall.

Right installation

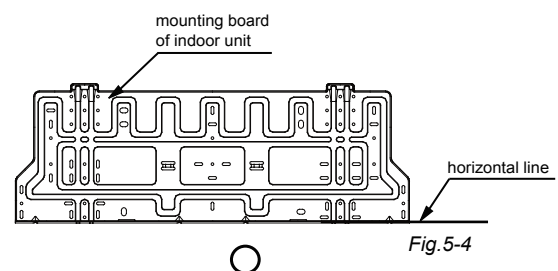

Fig.5-4

False installation

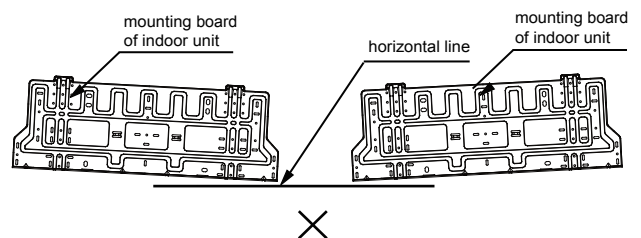

Fig.5-5

2 Drilling a hole.

- Determine the pipe hole position using the installation board, and drill the pipehole (N95mm) so it slants slightly downward.
- Always use a wall hole conduit when piercing metal lath, ply wood or metal plate.

5.3 Connective Pipe and Drainage Installation

1 Drainage

- Run the drain hose sloping downward. Do not install the drain hose as illustrated below.

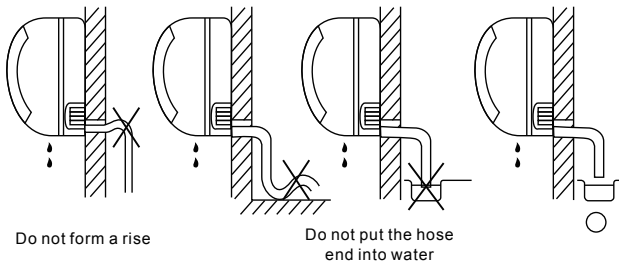

Fig. 5-5

- When connection extension drain hose, insulate the connecting part of extension drain hose with a shield pipe

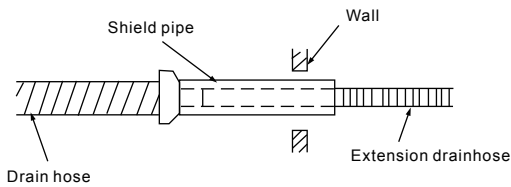

Fig. 5-6

2 Connection pipe

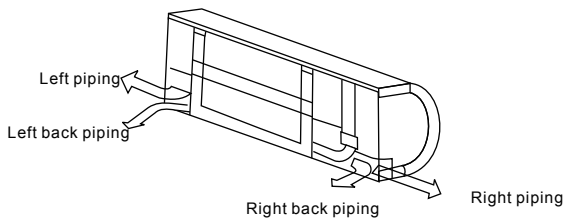

Fig. 5-7

- For the left-hand and rear-left-hand piping, install the piping as shown. Bend the connective pipe to be laid at 43mm height or less from the wall.

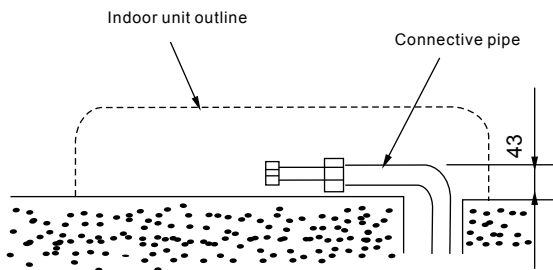

Fig. 5-8

- Fix the end of the connective pipe. (Refer to Tightening Connection in WATER PIPING INSTALLATION) After connecting, all connective pipe should be covered by heat-resistant materials.



CAUTIONS

Connect the indoor unit first then the outdoor unit and bend and arrange the pipe carefully.

Do not allow the piping to let out from the back of the indoor unit.

Be careful not to let the drain hose slack.

Insulate both of the auxiliary piping.

Banding the drain hose under the auxiliary pipe.

Do not allow the piping to let out from the back of the indoor unit.

3 Piping and bandaging

Wind the connective cable, drain hose and wiring with tape securely, evenly as shown below.

- Because the condensed water from rear of the indoor unit is gathered in Pond Box and is piped out of room. Do not put anything else in the box.

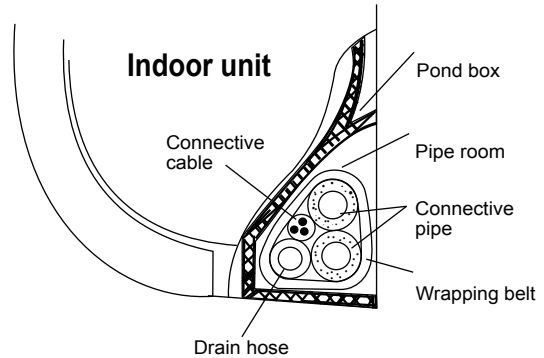

Fig. 5-9

5.4 Indoor Unit Installation

- Pass the piping through the hole in the wall.
- Put the claw at the back of the indoor unit on the hook of the installation board, move the Indoor Unit from side to side to see that it is securely hooked.
- Piping can easily be made by lifting the indoor unit with a cushioning material between the indoor unit and the wall. Get it out after finish piping.
- Push the lower part of the Indoor Unit up to the wall, Then move the Indoor Unit from side to side, up and down to check if it is hooked securely.

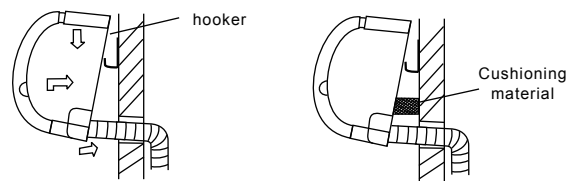

Fig. 5-9-

6. WATER PIPE INSTALLATION

6.1 Material and Size of the Piping

Table 6-1

| Pipe Material | Copper Pipe for Air Conditioner | |
|----------------------------------|---------------------------------|--------|
| Model | 42.5/51/68 | 85/102 |
| Coil connections (flat plate) | 3/4" | 3/4" |
| | 3/4" | 3/4" |

6.2 Connection of the Water Pipe

Connection of the water pipe should be done by professionals. Double-span should be used when connecting pipes of Indoor Unit.

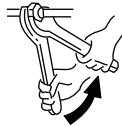

NOTE

Please refer to installation instructions for the water piping connection of the air conditioner that with throttle device inside.

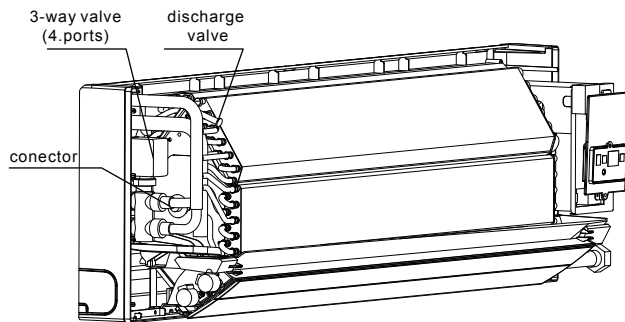

Fig. 6-1

- At the first debugging, completely expel air from coils via expelling valve.

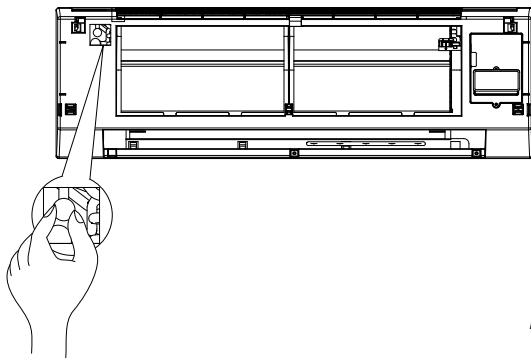

Fig. 6-2

7. WIRING CHART



CAUTIONS

The reserved function is indicated in broken line table, users can select it when necessary.

an all-pole disconnection device which has at least 3mm separation distance in all pole and a residual current device(RCD)with the rating of above 10mA shall be incorporated in the fixed wiring according to the national rule.

The appliance shall be installed in accordance with national wiring regulations.

- Take out the faceplate, then dismantle the display cover plate. (Refer to Fig 7-1)

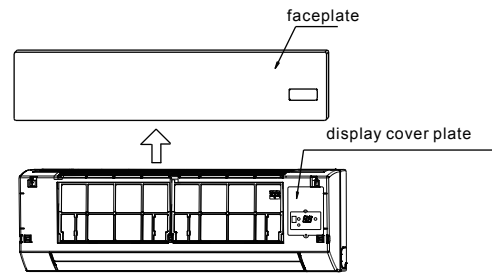

Fig. 7-1

- Individual connect the power cord and signal line, adjust the dial switch. (Refer to Fig 7-2)

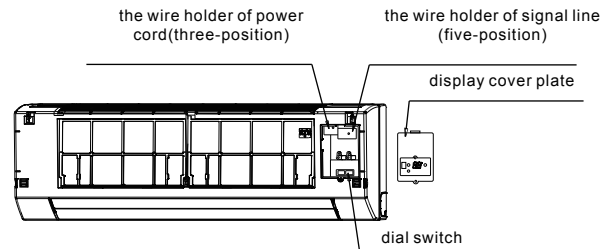

Fig. 7-2

7.1 Terminal Board Diagram

Please refer to the indoor unit wiring diagram for the wiring.



NOTE

The air-conditioners can connect with Central Control Monitor (CCM). Before operation, please wiring correctly and set system address and network address of indoor units.

- Single phase indoor unit

Table 7-1

| | | |
|--|--------------------|-------------------------------------|
| AIR FLOW(m ³ /h) | | 510~1020 |
| POWER | PHASE | 1-phase |
| | FREQUENCY AND VOLT | 220-240V~ 50Hz |
| CIRCUIT BREAKER/FUSE(A) | | 15/15 |
| INDOOR UNIT POWER WIRING(mm ²) | BELOW 20M | Twisted pairwire 2.5mm ² |
| | BELOW 50M | Twisted pairwire 6mm ² |
| GROUND WIRING(mm ²) | | 1.5 |

The power cord type designation is H05RN-F or above.

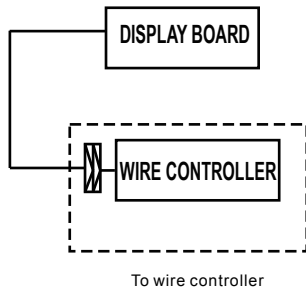

The reserved wire control function is indicated in broken line table, users can purchase the wire controller when necessary.

7.2 Network address set

Every air-conditioner in network has only one network address to distinguish each other. Address code of air-conditioner in LAN is set by code switch on Network Interface Module (NIM), and the set range is 0-63.

16126200000804